

EASY-LASER[®]



FLATNESS



PARALLELISM



SECTIONAL
METHOD

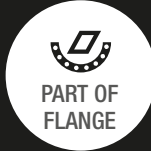

PART OF
FLANGE



Flange measurement

For manufacturers in the wind power industry



E910 / E915

A PRECISION CHOICE

is also a safe choice!

LONG EXPERIENCE

Easy-Laser® measurement systems have been developed from more than twenty five years experience of solving measurement problems for the industry. This is long enough to understand problems out in the real world. At the same time, we are young enough to see opportunities and solutions with fresh eyes. Taking full control from the initial idea to the finished product and working closely with our users, we are able to create user-friendly measurement systems.

USERS ALL OVER THE WORLD

Easy-Laser® measurement systems are available from local dealers in more than 70 countries, but there are users to be found in many more countries. Easy-Laser® products are used within the wind power generation industry on a daily basis, by companies such as Vestas, Suzlon, Gamesa, and DeWind among others. For them, professional tools and the best possible support are of great importance, and the same is no doubt true for you as well. Service and repair centres can be found all over the world for your convenience. You can be assured that we will provide you with the fastest and best possible support.

LARGE SAVINGS

Easy-Laser® measurement systems are already extremely flexible in their standard form. By using clever accessories, you can adapt the systems for your own needs, now and in the future as your measurement requirements change. It is cost-effective. Your production capacity increases by being able to measure faster and with greater reliability. Easy-Laser® helps you remedy production errors quickly and easily. This can save you large amounts of money, and your investment can even be repaid within a few months.

ERGONOMIC DESIGN

In order for you, as a user, to be able to focus on the job in hand, it is important that the tools are ergonomic. The display unit has large well-spaced buttons that give clear feedback when pushed. Two Enter buttons make the system suitable for both right and left-handed users. The display screen has clear graphics that guide you through the measurement process.

ANALYSING THE RESULT ON SITE

Easy-Laser® Flange system makes your daily work more efficient. You can see the result as a 3D image in the display unit immediately after measuring. You can evaluate the result with different calculation settings, for example “three point reference”, “best fit” or “all positive”. This can also be done directly on site without having to stop to go to a PC with separate analysis programs, which was the case previously. This makes production much more efficient.

LONG TERM/RELIABLE

Our philosophy is that the products we develop must not only have long operating times but also a long lifecycle. We design our products to be robust, with as few small parts as possible. Measurement systems from Easy-Laser® can withstand rough handling and work without fault in the most demanding environments. Easy-Laser® is the safest choice in all situations.

Examples of result summary for flatness measurement:

Max	0.11
Min	-0.11
Peak-peak	0.22
Standard deviation	0.06
Flatness RMS	0.07

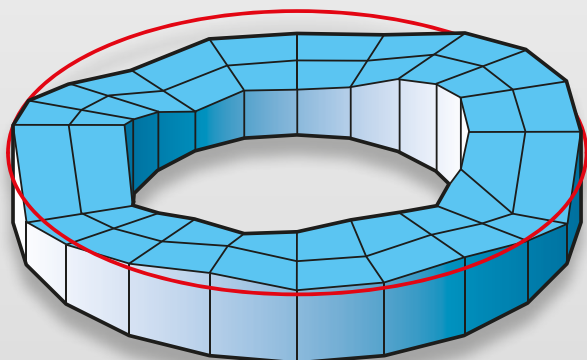

SIMPLE AND EFFECTIVE



Easy-Laser® D23 laser transmitter is placed directly on the flange. It has a motorised rotating head that creates a continuous laser plane over the entire measurement object, without hidden sectors.



The Easy-Laser® detector is positioned on the measurement point. As the laser beam constantly rotates, you only have to move the detector to each measurement point and register the measurement value. No time wasted repositioning the laser beam.



Once all measurement points have been registered, you can evaluate the results directly in the display unit. This can also be done directly on site without having to stop to go to a PC with separate analysis programs, which was the case previously. This makes production much more efficient.

FLATNESS OF FLANGES

FOR ALL TYPES OF FLANGE

Easy-Laser® Flange systems can be used on all sizes of flanges, regardless of diameter. You can measure 1 to 5 circles of measurement points, for example inner, middle and outer circles, in order to see the taper of the flange. Each circle can have 6–180 measurement points. The program guides you graphically step-by-step through the entire measurement, which quickens the measurement process. Two methods are available: Full circle measurement and Sectional measurement.

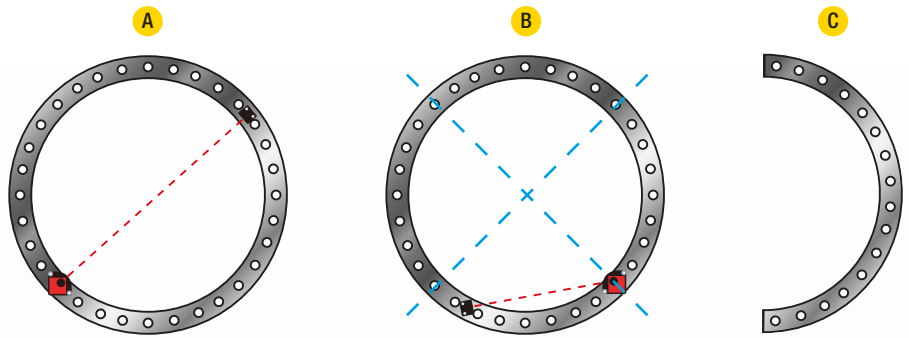

A. Full circle method. The detector on the magnet base is placed on the points that are to be measured, all around the flange. The tower is stationary during the measurement.

B. With the section measurement method, you measure the flange in four quadrants, then merge these into a full circle. The tower is rotated during measurement. Learn more on next page.

C. Other methods offered with the program are partial measurements, 1/2 of flange or 1/3 of flange.

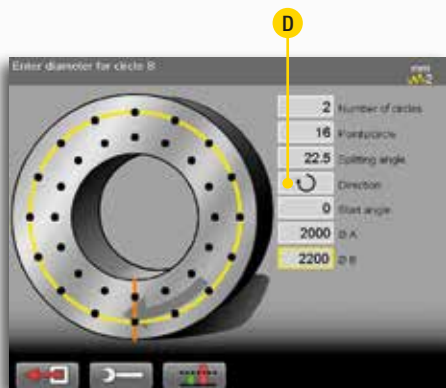

Enter the number of measurement points and the diameters. You can measure from 1 to 5 circles with measurement points. Set measurement direction (D).

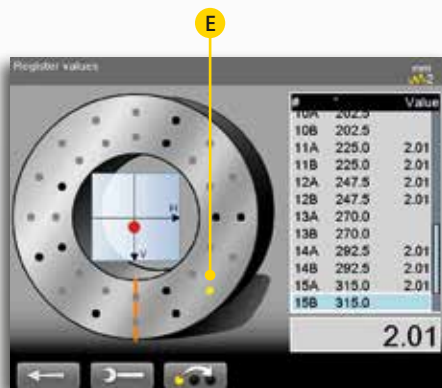

The point to be measured is indicated in the image. It is also possible to see from the display screen whether the laser beam hits the detector.

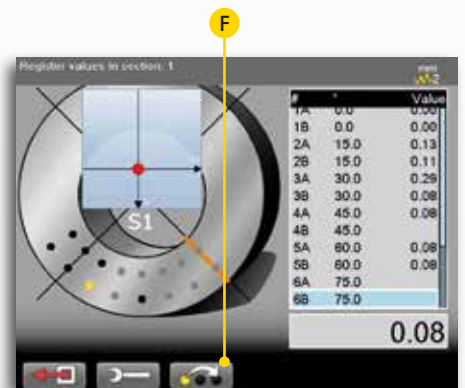

Display screen for section measurement method. Point 6 on outer circle to be measured. It is possible to skip any measurement point (F), in this example point 4B.

PARALLELISM OF TOWER FLANGES

PARALLELISM OF TOWER FLANGES

Easy-Laser® enables you to measure and check the parallelism of the flanges. This can be done in several ways, as shown to the right with system E910 for example. In addition to the standard equipment, two tripods and an angular prism are required.

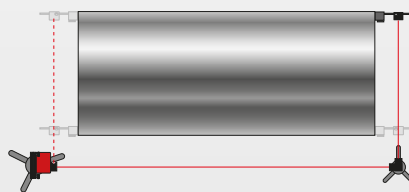

The laser transmitter (D22) is placed on a tripod beside one of the flanges. An angular prism (D46) is placed on a tripod beside the other flange. The detector is then placed on the given measurement points on both flanges.

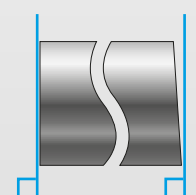

Unparallel flanges

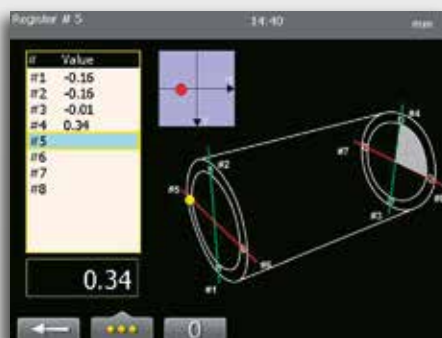

The program guides you step-by-step.

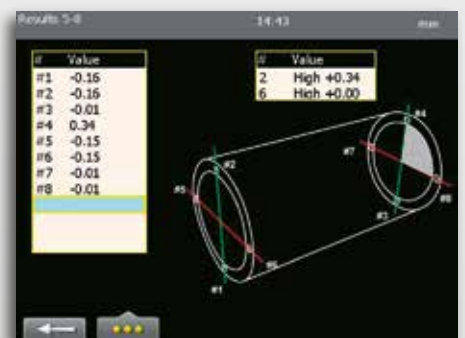

The result clearly shows any parallelism errors between both flanges.

EVALUATE DIRECTLY ON SITE

When the measurement of the flange is complete, the digits must then be interpreted. Easy-Laser® Flange systems make this extremely easy to do. And you can even do it on site, without having to go to a PC with separate analysis programs. This of course saves a lot of time. Time that you can use to measure more flanges. You can evaluate the result with different calculation settings, for example “three point reference”, “best fit” or “all positive”. The result is shown via graphics in true 3D.

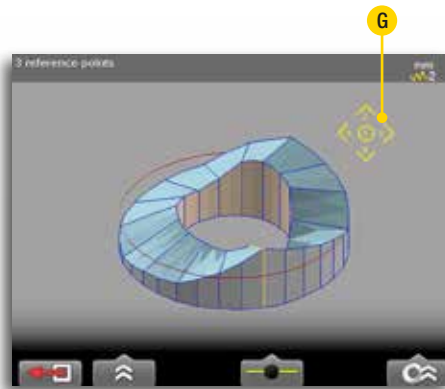

Example of true 3D graph. The image can be rotated and tilted (G) for best viewing angle.



Result diagram with Min. and Max. values.



Set tolerance values for flatness and taper.

#	A	B	C
1	0.0	-0.57	-0.15
2	18.0	-0.30	-0.35
3	36.0	-0.13	0.00
4	54.0	-1.12	-1.14
5	72.0	-1.14	-1.35
6	90.0	-1.11	-1.48
7	108.0	-1.03	-1.35
8	126.0	-1.00	-1.26
9	144.0	-0.92	-1.10
10	162.0	-0.80	-1.01
11	180.0	-0.70	-0.86
12	198.0	-0.59	-0.57
13	216.0	-0.56	-0.48

Result table with reference points marked (H). Red values are out of tolerance.



Taper values diagram. Taper out of tolerance (I).

FLANGE SECTIONAL PROGRAM

A tower section with diameter over 4 meters represents a significant weight. This weight causes the flanges to deform when the sections are manufactured. This also makes it difficult to rely on the flatness measurement result. Until now, that is. With Easy-Laser®'s new flange sectional measurement program the flatness is measured in four sections which are mathematically merged into a full circle. The new measurement program not only solves the flange deformation problem, but also makes it possible to perform the complete measurement on ground. This is the new safety standard for tower builders, since no climbing on ladders or skylift is required. With traditional methods on large diameters, the operator has to work on hazardous high levels, and often more men are needed. International patent pending.

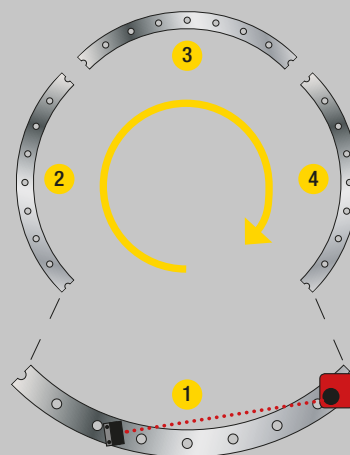

With the section measurement method, you measure the bottom quarter of the flange, then rotate the tower 90° and measure, for each of the following sections.



Safer for the technicians, since no climbing on ladders or skylift is required.

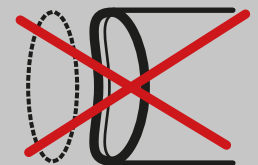

The measurement result is unaffected by the tower gravity deformation.

MANY OPTIONS

FLATNESS OF WING ROOT FLANGES

To check wing root flanges we offer special accessory fixtures. Depending on the construction of the flanges, if they are non-magnetic for example, the fixtures have different designs. Ask us about special solutions for your own designs.

FLATNESS OF HUB FLANGES

The flanges on hubs can be checked in the same way as the tower flanges. No need for extra equipment in addition to what is included in an Easy-Laser® E910/E915 Flange system.

FLATNESS OF TOWER FLANGES

The flatness of the tower flanges can be measured with an Easy-Laser® E910/E915 Flange system.

PARALLELISM OF TOWER FLANGES

With system Easy-Laser® E910 plus accessories angular prism and tripods you can measure the parallelism of the two flanges on a tower section.

FLATNESS OF FOUNDATIONS

A basic requirement for the machines to work under the right conditions is that the bases they stand on are flat. Easy-Laser® enables you to check this too. No need for extra equipment in addition to what is included in an Easy-Laser® E910/E915 Flange system.



DOCUMENTATION

CREATE A PDF REPORT DIRECTLY



It is possible to generate a PDF report containing graphs and measurement data directly in the measurement system's display unit. All the information about the measurement object is documented, and you can add your company's logo and address details if you so wish.

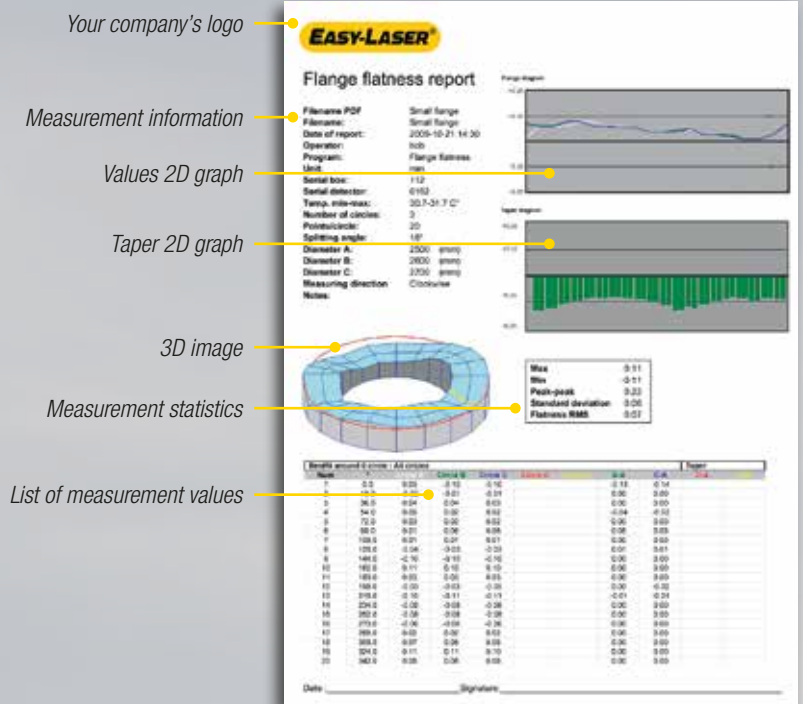

EASYLINK™



The measurement system includes EasyLink™ data base program for Windows® as standard. Here you can collate all your measurements in the same place and also make more advanced calculations, add images, export to Excel® documents etc.

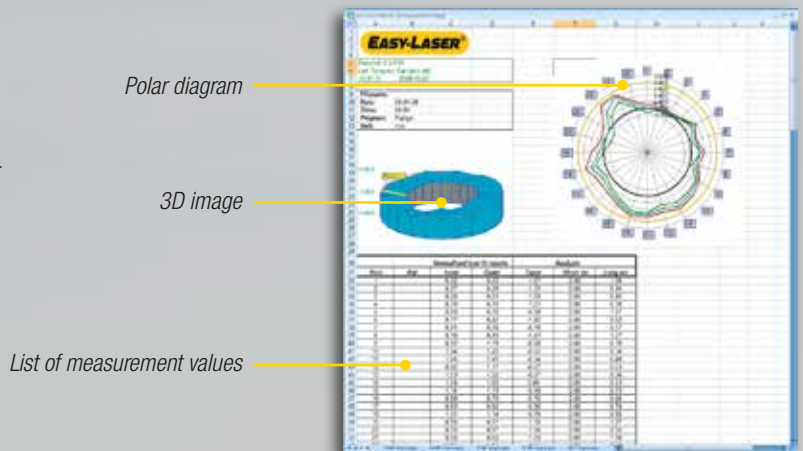

CONNECT TO YOUR COMPUTER



The display unit is connected to the computer via the USB port. It then appears on the desktop as a "Mass Storage Device" which you can easily transfer files to and from.

SAVE TO USB MEMORY



You can easily save desired measurements on your USB memory. This enables you to take it to your computer to print reports whilst leaving the measurement system in place to continue measuring.



SAVING IN THE BUILT-IN MEMORY



You can, of course, save all measurements in the display unit's internal memory. You can then open an old measurement and remeasure those points you adjusted, or start from a new measurement avoiding having to enter certain necessary dimensions such as diameter, number of measuring points etc.

BARCODE READER



The barcode reader is used to enter the measurement object data automatically before measurement, which can save you time, and minimizes errors.



THE PARTS OF THE SYSTEM

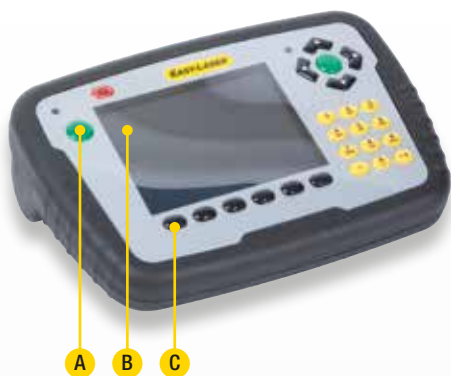

- A. Two Enter buttons, for left and right-handed users
- B. Large, easy to read colour display
- C. Proper buttons for clear feedback



- D. Thin profile gives a perfect grip for your hands
- E. The integrated battery compartment design gives the correct angle on the display screen
- F. Battery compartment
- G. Mounting for shoulder strap

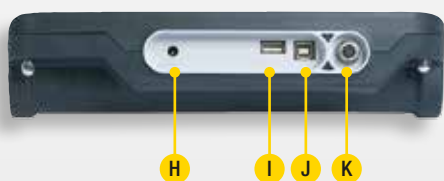

- H. Connection for charger
- I. USB A
- J. USB B
- K. Easy-Laser® measurement equipment



- L. Dust and splash guards for connectors that are not used when measuring
- M. Robust, rubber coated design

DISPLAY UNIT

The display unit for the E series enables you to work more efficiently and for longer than ever before thanks to several innovative solutions. It is also ergonomically designed with easy-to-grip rubber cladding and robust construction.

PERSONAL SETTINGS

You can create a user profile where you can save your personal settings. You can also have different settings for different types of measurements, and save them as Favorites, for quick access from the main menu.

LANGUAGE SELECTION

Initially English, German, French, Spanish, Portuguese, Swedish, Finnish, Russian, Dutch, Polish, Italian, Japanese, Korean and Chinese are available. More languages to follow.

ERGONOMIC

The display unit has a thin, easy-to-grip and rubber coated profile that ensures a secure grip. It has large well-spaced buttons that give clear feedback when pushed. In addition, the two Enter buttons make the system suitable for both right and left-handed users. The display screen has clear graphics that guide you through the measurement process.

UPGRADING

If you wish to expand functionality in the future, the software in the display unit can be upgraded via the internet or by connecting a USB memory containing the new software.

VALUES PROGRAM

All our measurement systems come with the extremely useful Values program. With this, you can, in principle, measure any type of geometry, for example straightness and squareness. Many Easy-Laser® users therefore end up using the measurement system in many more places in their operation, than they first intended!



Values program



Calculator

BUILT-IN HELP FUNCTIONS

We have integrated a calculator and conversion tool for length units in the display unit.

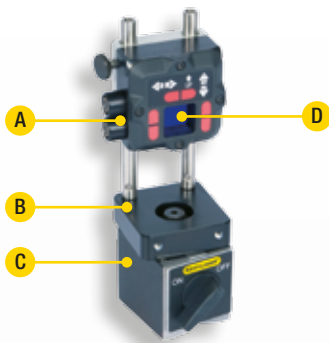

- A. Well protected connectors
- B. Rotatable head
- C. Magnet base
- D. PSD (2 axis)



DETECTOR E5 AND E7

Detector E5 is included in system E915. It can work with stationary and rotating lasers (see below) thanks to our Dual Detection Technology™. Detector E7 is included in system E910. Both detectors connect to the display unit via cable or wirelessly. The magnet base has a rotating head to align the detector to the laser transmitter.



WIRELESS COMMUNICATION

The unit for wireless communication is easily inserted into one of the connectors on the detector. Wireless connection to the display unit enables you to work more freely.



- A. Rotatable head with angular prism
- B. Release lever
- C. Tilting table

LASER TRANSMITTER D22

Laser transmitter D22 can be used to measure flatness, straightness, squareness and parallelism. The laser beam can sweep 360° with a measurement distance of up to 40 metres [130'] in radius. The laser beam can be angled 90° to the sweep, within 0.01mm/m [0.01 mils/INCH].

This transmitter is included in system E910.

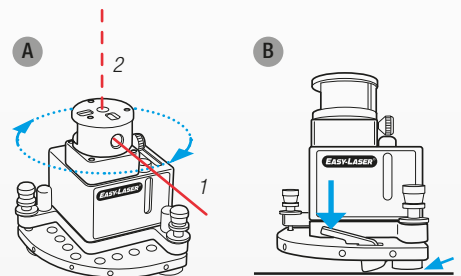

- A1: the laser beam is used for a 360° sweep.
- A2: the laser beam is angled at 90° to the sweep.
- B: Easy to release the transmitter with the lever.



- A. Rotating head (motor driven)
- B. Release lever
- C. Tilting table

LASER TRANSMITTER D23 SPIN

Laser transmitter D23 has a motor driven, rotating head that gives a 360° laser plane. Measurement distance up to 20 metres [65'] in radius.

This transmitter is included in system E915.

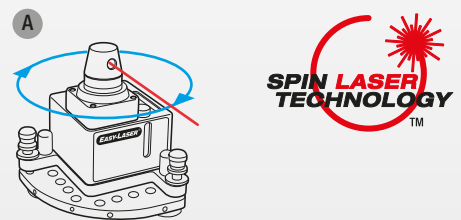

The laser beam is used for a 360° sweep. Because the laser beam sweeps across the surface you do not need to align the beam for every detector position. Convenient!

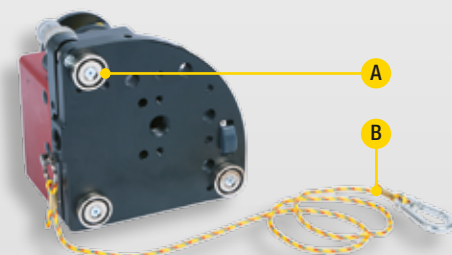

- A. Super magnets
- B. Safety strap

POWERFUL ATTACHMENT MAGNETS

Both D22 and D23 laser transmitters are installed against the flange using three super magnets. Hold the transmitter securely, even vertically.

SAFETY STRAP

The safety strap provides good protection against unexpected events, if someone knocks the laser transmitter for example. Easy to attach, through a bolt hole for example.

EXPANDABILITY

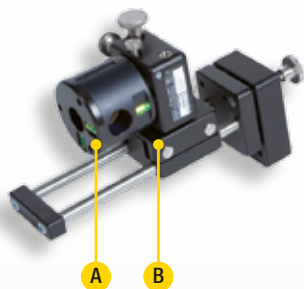

A. Angular prism, rotates 360°
B. Sliding sled

ANGULAR PRISM

Angular prism D46 is used for parallelism measurement of the flanges. It deflects the laser beam 90°.

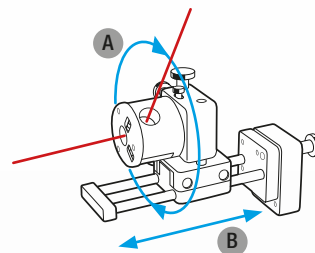

A. With the rotatable angular prism you can reach the detector anywhere on the flange.
B. It is quick and easy to align the beam with the detector using the sled.



TRIPOD

Tripod for use with angular prism D46 and laser transmitter D22/D23.

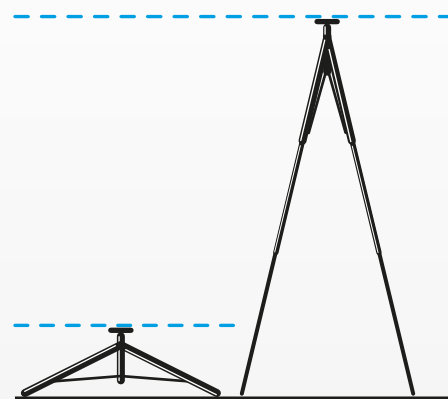

The height of the tripod can be adjusted between 500 and 2730 mm.

WING FLANGE FIXTURES

To check the wing flange flatness, we have various different fixtures. The biggest difference depends on whether the flange is magnetic or not. Contact us for further information.



TECHNICAL DATA

System	
Relative humidity	10–95%
Weight (complete system)	12.1 kg [26.7 lbs]
Carrying case	WxHxD: 550x450x210 mm [21.6x17.7x8.3"] Drop tested. Water and dust tight.

Laser transmitter D22 (system E910)	
Type of laser	Diode laser
Laser wavelength	635–670 nm, visible red light
Laser Safety Class	Class 2
Output	< 1 mW
Beam diameter	6 mm [1/4"] at aperture
Working area, range	40-metre radius [130']
Type of battery	1 x R14 (C)
Operating time/battery	approx. 24 hours
Operating temperature	0–50 °C
Levelling range	± 30 mm/m [± 1.7"]
3 x spirit vials' scaling	0.02 mm/m
Squareness between laser beams	0.01 mm/m [2 arc sec.]
Flatness of sweep	0.02 mm
Fine turning	0.1 mm/m [20 arc sec.]
2 x spirit vials for rotation	5 mm/m
Housing material	Aluminium
Dimensions	WxHxD: 139x169x139 mm [5.47x6.64x5.47"]
Weight	2650 g [5.8 lbs]

Laser transmitter D23 (system E915)	
Type of laser	Diode laser
Laser wavelength	635–670 nm, visible red light
Laser Safety Class	Class 2
Output	< 1 mW
Beam diameter	6 mm [1/4"] at aperture
Working area, range	20-metre radius [65']
Type of battery	2 x R14 (C)
Operating time/battery	approx. 15 hours
Operating temperature	0–50 °C
Levelling range	± 30 mm/m [± 1.7"]
3 x spirit vials' scaling	0.02 mm/m
Flatness of sweep	0.02 mm
Housing material	Aluminium
Dimensions	WxHxD: 139x169x139 mm [5.47x6.64x5.47"]
Weight	2650 g [5.8 lbs]

Detector E7 (system E910) and E5 (system E915) (*Note! Only with E5)	
Type of detector	2 axis PSD 20x20 mm [0.78" sq]
*Dual Detection Technology™	Can detect both spinning and stationary laser beam
Resolution	0.001 mm [0.05 mils]
Measurement error	± 1% +1 digit
Inclinometers	0.1° resolution
Thermal sensors	± 1° C accuracy
Environmental protection	IP Class 66 and 67
Operating temperature	-10–50 °C
Internal battery	Li Po
Housing material	Anodized aluminium
Dimensions	WxHxD: 60x60x42 mm [2.36x2.36x1.65"]
Weight	186 g [6.6 oz]

Display unit	
Measuring programs	Flange flatness / Flange parallelism / Values
Type of display/size	VGA 5.7" colour
Displayed resolution	0.001 mm / 0.05 thou
Power management	Endurio™ system for unbroken power supply
Internal battery (stationary)	Li Ion
Battery compartment	For 4 pcs R 14 (C)
Operating time	Appr. 30 hours (Normal operating cycle)
Operating temperature	-10–50 °C
Connections	USB A, USB B, Easy-Laser® units, Charger
Wireless communication	Class I Bluetooth® Wireless Technology
Storage memory	>100,000 measurements
Help functions	Calculator, Unit converter, Instruction films
Environmental protection	IP Class 65
Housing material	PC/ABS + TPE
Dimensions	WxHxD: 250x175x63 [9.8x6.9x2.5"]
Weight (without batteries)	1030 g [2.3 lbs]

Wireless connection unit	
Wireless communication	Class I Bluetooth® Wireless Technology
Operating temperature	-10–50 °C
Environmental protection	IP Class 66 and 67
Housing material	ABS
Dimensions	53x32x24 mm [2.1x1.2x0.9"]
Weight	25 g [0.9 oz]

Cables	
Type	With Push/Pull connectors
System cable	Length 2 m [78.7"]
Extension system cable	Length 5 m [196.8"]
USB cable	Length 1.8 m [70.8"]

Magnet base with turnable head (for detector)	
Holding power	800 N

Rods for detector	
Length	60 mm / 120 mm (extendable) [2.36"/4.72"]

EasyLink™ data base software for PC	
System requirements	Windows® XP, Vista, 7, 8. For the export functions, Excel 2003 or newer must be installed on the PC.

A complete system contains	
1	Laser transmitter D22 (only system E910)
1	Laser transmitter D23 (only system E915)
1	Detector E7 (only system E910)
1	Detector E5 (only system E915)
1	Display unit E51
1	Bluetooth unit
1	Cable 2 m
1	Cable 5 m (extension)
1	Cable support
1	Safety strap for laser transmitter
3	Targets for rough alignment
1	Magnet base with turnable head
1	Set of rods (6x60 mm, 6x120 mm)
1	Manual
1	Quick manual
1	Measuring tape 5 m
1	USB memory stick (with EasyLink™ program)
1	USB cable
1	Battery charger (100–240 V AC)
2	Batteries Alkaline R14
1	Toolbox
1	Cleaning cloth for optics
1	Carrying case

System Easy-Laser® E910 Flange, Part No. 12-0525
System Easy-Laser® E915 Flange, Part No. 12-0526





LONG WARRANTY PERIOD

The Easy-Laser® systems are developed with the backing of more than 25 years' experience of solving measurement and alignment problems for the industry, all over the world. The systems come with a generous three year warranty*. The manufacturing and quality systems are approved according to ISO9001.



QUICK SERVICE

Our service department usually takes care of servicing or calibration within five working days. All this makes Easy-Laser® a safer working partner for your operation. As an extra service, we provide a 48 hour express service for when accidents occur and time is of the essence. Contact us for further information about terms and conditions.



IN-HOUSE EXPERTISE

We take care of the entire chain internally, from idea to the end product. Our development department consists of designers who specialise in mechanics, electronics, optics and programming.

CLEVER DESIGN

Our development department continuously strives to simplify the user's work through innovative and clever solutions. It is the collaboration between laser transmitter, detector and software that is the key to a quick and easy measurement. This is where Easy-Laser® shines.

CUSTOM DESIGN

In addition to our already versatile standard system we can also specially adapt measurement systems to suit your needs, something we are proud of being able to offer. Using our own CNC machines we can quickly manufacture fixtures just for you.

* Extend the warranty from 2 to 3 years by registering your system on the Internet.

Easy-Laser® is manufactured by Easy-Laser AB, Alfagatan 6, SE-431 49 Mölndal, Sweden
 Tel +46 31 708 63 00, Fax +46 31 708 63 50, e-mail: info@easylaser.com, www.easylaser.com
 © 2016 Easy-Laser AB. We reserve the right to make changes without prior notification.
 Easy-Laser® is a registered trademark of Easy-Laser AB. Other trademarks belong to the relevant copyright holder.
 This product complies with: EN60825-1, 21 CFR 1040.10 and 1040.11. Contains FCC ID: PVH0925, IC: 5325A-0925.
 Extend the warranty from 2 to 3 years by registering your system on www.easylaser.com
 05-0436 Rev7

